

**SAMSUNG**



**SAMSUNG Flip**  
Flip the Future of Collaboration

**SAMSUNG**

SAMSUNG **Flip**

## Transform the Modern Meeting

The meeting is the foundation of today's business world. It also can be one of its most challenging elements. Between preparing and moving supplies, finding a room and making sure every voice is heard, it's easy for game-changing ideas to get lost in the process.

Introducing the Samsung Flip, an interactive display that drives more productive and efficient collaboration without the hassle. With the Samsung Flip, meetings can take place anywhere and at any time, with all vital elements included.

Business meeting logistics no longer need to be stressful. Envision how the Samsung Flip can help you and your team work smarter, faster and better.



# FI!P Innovation

Whatever your collaborative needs, the Samsung Flip display can improve the quality of any meeting. See your ideas come to life in clear UHD picture quality. Activate the display through sensor recognition to ensure your meeting starts on time. And make any location a meeting space through a portable, wheel-based stand. Facilitators and participants can trust the Samsung Flip to enliven any conversation.



## FI!P Display

Samsung Flip presents all critical ideas in a clear and consistent format. Regardless of annotation size or style, the Flip display maintains brilliant, eye-friendly UHD picture quality. In turn, you and your colleagues can follow the conversation and remain engaged at all times.



UHD



## FI!P Touch

Samsung Flip is the ideal forum for simultaneous interaction. Up to four different meeting participants can make notes using the embedded pen or virtually any writing tool. Additionally, you can sync and control content from your personal device to the central screen for efficient collaboration.



InGlass™



Multi-writing  
up to 4



4 width object  
recognition



Touch out  
control\*

\*Touch Out Control is available through a touch USB cable connection or UIBC-connected Android mobile devices (2016 or later) and Windows 10 PCs.

## FLIP Design

Whether for a quick discussion or lengthy presentation, meeting notation no longer needs to be uncomfortable. Customize and work within your ideal writing dimensions. Leverage the optimized pivot height to automatically align the Flip to an ideal level. Utilize the ergonomic 4.5 degree tilt in portrait mode for a more natural writing angle. And configure the display in portrait or landscape orientations to maximize available writing space.



Easy moving  
4-wheel



Convenient  
pen holder



Spacious tray



4.5° tilt in  
portrait mode



## FLIP Solution

The workday is busy, and you cannot afford to lose any time. The Samsung Flip accommodates these demands and ensures that meetings start on time. Embedded sensors automatically activate the display when you approach or remove the pen from the holder. Samsung Flip also stores meeting notes in real-time, preventing the need to stop conversation to save each page.



Tizen



Sensor based



Internal  
storage

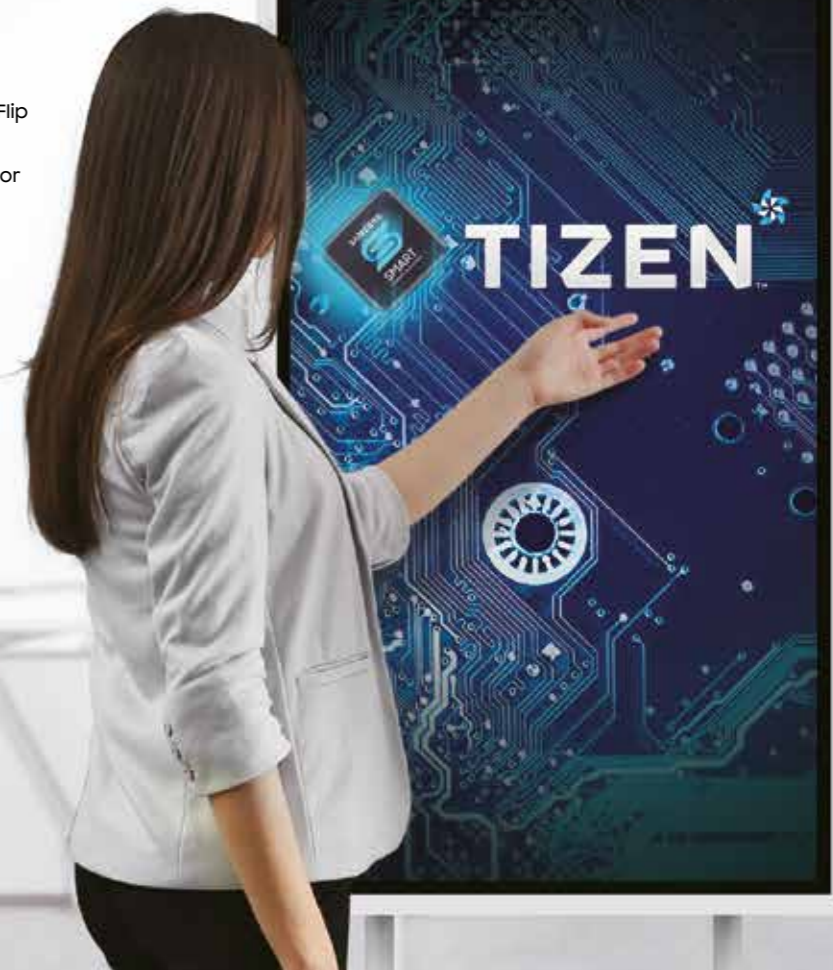



# FIIP Experience

Take your traditional meeting to the next level. Through the Samsung Flip's mobile connectivity, you can introduce images, charts or other essential files directly from your personal devices...all in a clear, easy-to-read format. Better yet, the Samsung Flip expands creativity without sacrificing comfort, providing the same familiar writing experience as that of a standard analog board or piece of paper. Expand your collaborative capabilities without losing the meeting essentials.

## FIIP Notation

The Samsung Flip enables you and your colleagues to bring your unique style to the conversation. The display showcases smooth, fast writing in a variety of colors and depths, with compatibility for multiple writing tools. Need to erase a previous note? You can quickly clear either a small section or full screen worth of content using a hand swipe motion.



Passive pen



Smooth & fast



Flexible erasing





# FLIP Connection

Standard meeting technologies make it difficult to locate the input sources required to connect external devices. Samsung Flip's versatile connectivity makes dedicated USB, note PC, and tablet and mobile devices ports readily available, saving valuable meeting time while extending participation capabilities

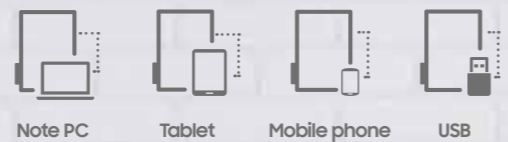

# FLIP Synchronization

Today's workers rely on their mobile devices to stay productive more than any other workplace tool. The Samsung Flip supports the mobile movement through extensive connectivity that makes on-screen content visible without interruption. And through integrated NFC and screen mirroring technologies, participants can mirror materials directly from their smartphone onto the central screen.



\*Samsung Galaxy Series devices (2016 or later) with an updated Android Oreo OS can launch screen mirroring via NFC tagging  
 \*Samsung Galaxy Note 8 and Galaxy Series devices (2016 or later) with an updated Android Oreo OS support full screen mirroring in portrait mode





## FIIP Navigation

You and your colleagues no longer have to sort through stacks of paper charts to find specific ideas or conversations. Samsung Flip eliminates this tiresome process by housing all meeting notes in a central storage database, with convenient search and navigation functionalities capable of locating a specific item in seconds. Detailed previewing also shows how a recap will look before it is shared with live and remote participants.

-   
Page preview
-   
Quick finder
-   
Capture & annotation



## FIIP Presentation

The Samsung Flip offers added flexibility for a flawless presentation in any desired format. Regardless of huddle room dynamics, you and your colleagues can showcase content in portrait or landscape mode thanks to convenient pivot functionality. The Samsung Flip also upholds steady organization through clear page dividers, with the ability to quickly scroll through up to 20 pages at a time.

-   
Pivot
-   
Up to 20 pages
-   
Seamless scroll



## FIIP Distribution

If you have ever had to capture handwritten meeting notes or send a detailed recap to your team, you understand how frustrating wrap-up can be. Samsung Flip eliminates the need for this cumbersome process through easy storage and distribution. Now, you can instead send digital notes to your colleagues via email, printing\*, and network or USB storage, saving time while also preventing important ideas from being erased, ruined or lost.



\*Flip users can print notes only via a Windows 7 or 10 OS-powered server or machine. Server software also is available at [www.samsung.com](http://www.samsung.com) or [displaysolutions.samsung.com](http://displaysolutions.samsung.com)

-   
E mail
-   
Printer
-   
Network Storage
-   
USB Storage



## FIIP Protection

Although the Samsung Flip allows for many users and access points, it also ensures that confidential meeting information remains in the right hands. Trust the Flip's airtight, password-based security system to safeguard your most important documents. The result is a more free and boundless exchange of ideas that any business can benefit from.

-   
Setting password
-   
Lock/Unlock

# Flip story

Regardless of your industry or work environment, the Samsung Flip is the perfect addition for any meeting needs. The Flip's diverse functionalities accommodate both creative and information-based operations, creating a more seamless and interactive team dynamic. Any market and team stands to benefit from the faster, clearer and more organized exchange of ideas now made possible by the Samsung Flip.







# FI!P Ideas

**Design Boutique**  
Explore Unlimited Creative Possibilities

Samsung's interactive Flip display empowers creatively-rooted businesses to develop messages that resonate with colleagues and clients. Visual storytellers can customize text styles, colors and sizes, all while enjoying a familiar and comfortable writing experience. The Samsung Flip also offers sufficient writing space and centralized storage to ensure an uninterrupted exchange of game-changing ideas.



# FI!P Insights

**Digital Marketing Agency**  
Condense Widespread Collaboration to a Single Space

For projects involving multiple stakeholders and documents, Samsung's Flip display drives more centralized and efficient teamwork. Up to four participants can write simultaneously, and facilitators and attendees also can introduce new Ideas and content from connected mobile devices. As meetings conclude, participants can digitally share and review notes, eliminating the need for a written recap.



# FI!P Views

**Architect Office**  
Expand the Workspace in an All-in-One Format

Narrow work spaces and stacks of paper often prevent architects' ideas from reaching full potential. Through streamlined creativity and organization, Samsung's Flip display helps architects achieve more efficient design, presentation and supervision. Centralized storage prevents misplacement by housing all relevant documents in a single, easily-accessible location. The Flip's pivot flexibility also extends available comfortable drawing space in both portrait and landscape modes.

# FI!P Spaces

**Communal Office**  
Transform any Space into a Huddle Room

For businesses with limited meeting space, Samsung's Flip display opens new avenues for idea generation. The display's portable stand transforms any space into a meeting room, with convenient wall mounts also available for temporary installations. For added convenience, the Flip's central screen, push button and pen lift recognition immediately activate the display and ensure that meetings start on time. A sleek, stylish design also brings performance and sophistication to any meeting environment.



Flip set			
Panel	Diagonal Size	55"	
	Type	60Hz E-LED	
	Resolution	"3,840 x 2,160 (Landscape) 2,160 x 3,840 (Portrait)"	
	Brightness(Typ.)	300 (without glass), 220 (with glass)	
	Contrast Ratio(Typ.)	4700:1 (Typ.)(without glass)	
	Viewing Angle(H/V)	178:178	
Sound	Response Time(G-to-G)	8ms(Typ.)	
	Speaker Type	Built in Speaker (10W x 2)	
Connectivity	INPUT	RGB	-
		VIDEO	HDMI 1
		AUDIO	-
		USB	USB 2 (ver 2.0x2, Side 1, Sensor Assy 1)
	OUTPUT	RGB	-
		VIDEO	-
		AUDIO	-
		Touch Out	Touch Out 1 (Side, USB Upstream Type)
	INTERNAL SENSOR	NFC, Acceleration sensor, Proximity Sensor	
	EXTERNAL CONTROL	"Touch Input RJ45 (not for User Control)"	
Touch	Type	Advanced IR	
	# of Drawing	4 drawing	
	Touch Pen Type	Passive Pen	
	Object Recognition Range	2mm/ 4mm / 8mm / 50mm	
	Touch Response Time	"38ms ~ 46ms (According to number of Multi Drawing)"	
Power	Type	Internal	
	Power Supply	AC 100~240V 50/60Hz	
	Power Consumption	Max[W/h]	165
		Typical[W/h]	100
		Rating[W/h]	150
		Stand-by[W/h]	0.5
		BTU[W/h]	562.65
Dimension (mm)	Set	1302.6(W) * 805.5(H) * 52.0(D)	
	Package	1469(W) * 924(H) * 210(D)	
Weight (kg)	Set	28.9	
	Package	34.9	
"Mechanical Spec"	Color	Light Gray	
	VESA Mount	400 x 400	
	Protection Glass	Yes	
	Stand Type	Moving Stand(Acc), Wall Mount	
	Media Player Option Type	N/A	
	Rotation	"Available with Flip Stand (Rotation Sylander Included)"	
Operation	Power Cable Length	3m	
	Accessory	Cover-Jack	
	Operating Temperature	0°C- 40°C	
	Humidity	10~80%	

Flip set			
Feature	Key	H/W	Flip App
		S/W	Super Clear Coating, Temperature Sensor, Pivot Display, Clock Battery(168hrs Clock Keeping), Built in Speaker(10W x 2), WiFi Module Embedded
	"Internal Player (Embedded H/W)"	Platform	Kant-M (Tizen 3.0)
		Processor	CA72 Quad(1.7GHz)
		"On-Chip Cache Memory"	"L1 (I/D) : 32KB / 32KB L2 (Unified) : 1MB"
		Clock Speed	1.7GHz CPU Quad
		"Main Memory Interface"	LPDDR4 1400MHz 64bit 3GB
		Graphics	" 2D & 3D Graphics Engine - Up to 1920x1080. 32bpp - Supports OpenGL ES"
		Storage	"8GB (2.65GB Occupied by O/S, 5.35GB Available,)"
		Multimedia	" *Video Decoder : MPEG-1/2/4, H.263, H.264/AVC, UHD H.264/AVC, VC-1, AVS+, HEVC, JPEG, PNG, VP8, VP9 *Audio Decoder : AC3 (DD), MPEG"
		IO Ports	USB 2.0
		Operating System	Samsung Proprietary OS(VDLinux)
Accessories	Included	Passive Pen(2), Power Cable, Touch Out Cable (USB upstream)	
	Optional	Stand	STN-WM55H
		Mount	WMN-6575SD
Media Player	CPU	Flip UX	
	N/B		
	S/B		
	GPU		
	FDM/HDD		
	Memory	N/A	
	Ethernet		
Connectivity	USB		
	Output		
	Others		

Flip stand			
Mechanical Spec	Dimension (mm)	Set	1023 x 1611 x 991 mm
		Package	31.7 kg
	Weight (kg)	Set	1,682 x 221 x 1,038 mm
		Package	41.8 kg
Connectivity	Color	Light Gray	
	VESA Mount	400 X 400	
	Rotation	Pivot Supports (90°)	
Accessories	Extention Connectivity from SET	HDMI 1 / Touch Out 1 / RJ45 1 / Power1	
Feature	Special	H/W	Installation Guide Rotation(4-Wheels) / Pivot(90°) / Pen & NotePC Tray (Rear)

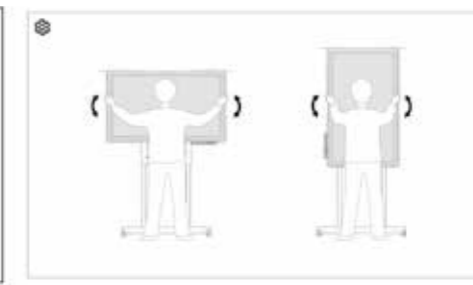
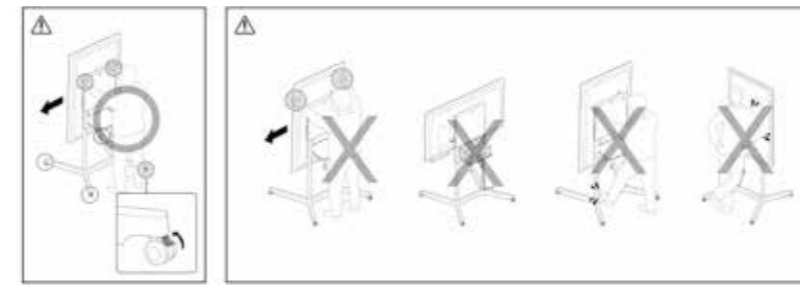
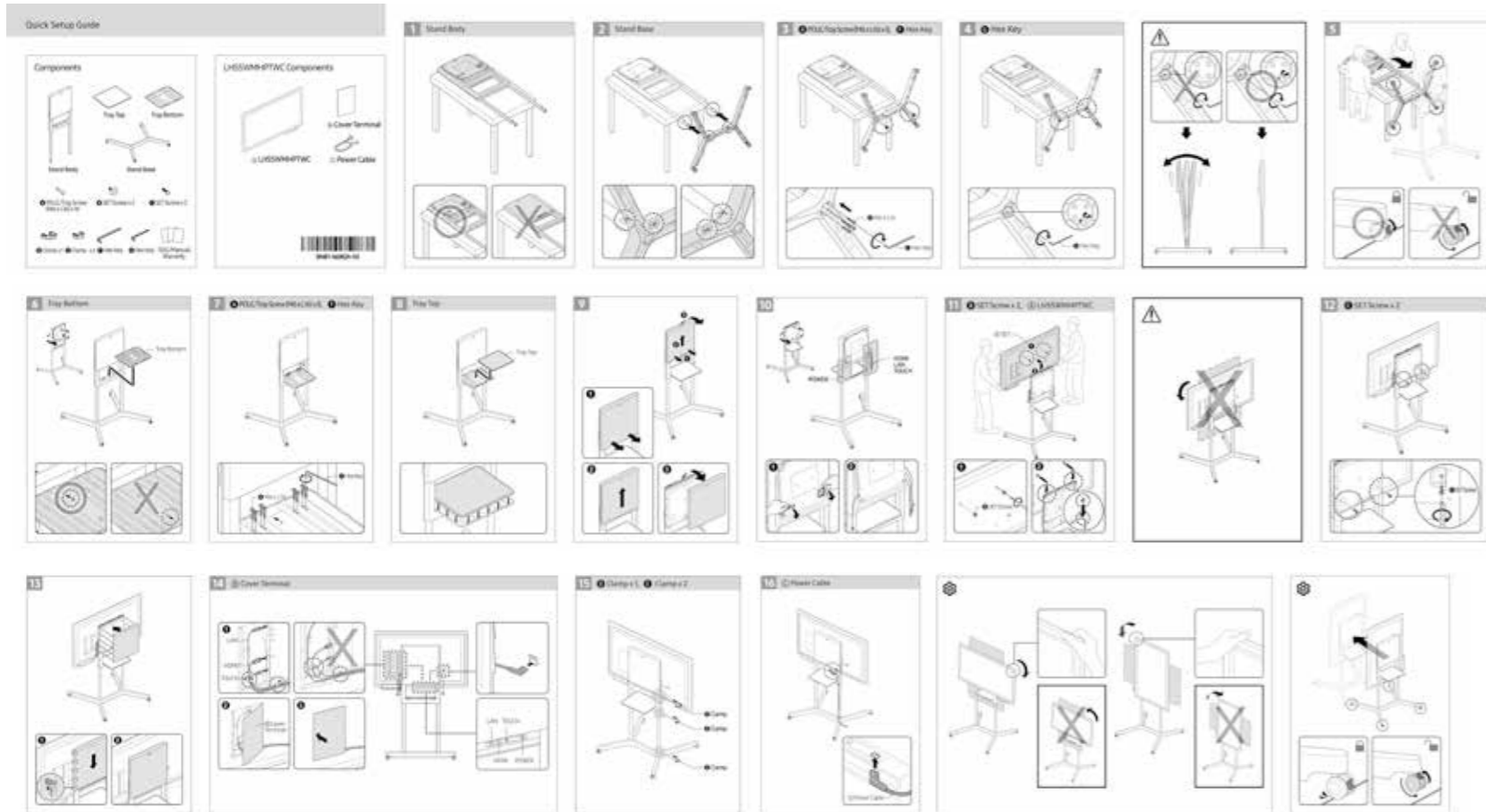

Model Name	STN-WM55H
Size (W x H x D)	1039 x 1922 x 1007 mm
Size (W x H x D)	Landscape (180° Flip): 1303 x 1804 x 1007 mm
Size (W x H x D)	Portrait (90° Flip): 1039 x 1967 x 1007 mm
Weight (Without Pkg)	41.2 kg (9.0 kg)
Packing Size (W x H x D)	1482 x 2214 x 1038 mm
Packing Weight	41.8 kg (9.0 kg)
Compatible Model	LMS5000P7MC

**Technical drawing**



FIIP Landscape Dimension

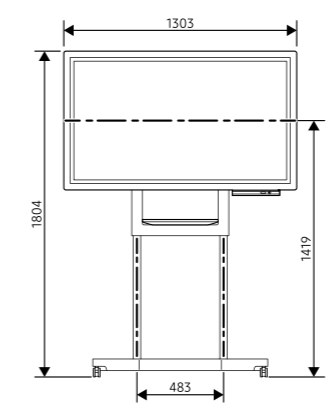

FIIP Portrait Dimension

